



M.J.S.A. Junior Championship

June 26, 2011
Pembina Triangle Gun Club

Provincial Trapshooting Championship

July 8, 9 & 10, 2011
Portage Plains Gun Club

International Trap Provincials

August 6 & 7, 2011
Winnipeg Trap and Skeet Club



www.manitobatrapshooting.com

2011 SHOOTING PROGRAM



HUNTING - FISHING - CAMPING - OPTICS - CLOTHING



BROWNING



**FEDERAL
PREMIUM[®]
AMMUNITION**



WINCHESTER
REPEATING ARMS



BERETTA

Remington

**SPECIALIZING IN QUALITY FIREARMS
AMMUNITION AND HUNTING ACCESSORIES**

Calgary
25 Heritage Meadows Way SE
(403) 253-5566

Edmonton - North
12610 St Albert Tr NW
(780) 477-3737

Edmonton South
2033-98 Street NW
(780) 461-2001

Lethbridge
3160 Fairway Street South
(403) 327-5760

Grande Prairie
11120-100 Avenue
(780) 532-3300

Regina
3112 Quance Street
(306) 522-0661

Winnipeg
1225 St. James Street
(204) 663-1094

Saskatoon
2828 Idylwyld Dr. N
(306) 931-4475

Nanaimo
4900 Wellington Road
(250) 729-2668

Kamloops
925 Notre Dame Drive
(250) 377-3966

Langley
20175 Langley Bypass
(604) 530-3413

Toll Free
1-800-696-0253

www.wholesalesports.com

Table of Contents

President's Message	4
Manitoba Trapshooting Association Update	5
Manitoba 2011 Trapshooting Schedule.....	6
Shooter's Responsibility	7
Respect in Sport Policy	8
Classification for all Manitoba Trap Clubs	9
2011 Saskatchewan Registered Shoots and Meeting Dates	10
General Information for all Manitoba Trap Clubs	12
Manitoba Trap Association 2011 Board of Directors	13
Affiliated Manitoba Trap Clubs and Directors.....	14
Manitoba Trapshooting Hall of Honor.....	15
Winnipeg Open	18
Youth Trapshooting	19
Brandon Westman Open	22
Winnipeg International Trap	28
Winnipeg International Trap Fun Shoot.....	29
How to Keep an Average Card	31
Pembina Triangle Summer's Here Now	32
Pembina Triangle MJSA Provincial Championship.....	33
Portage Plains Provincial Championships.....	36
Winnipeg Grand Alternative	44
2011 Grand American	48
Winnipeg International Trap	49
Lundar Gun Club	50
Pembina Triangle Trap Club.....	52
Pembina Triangle Trap Club Doubles Day	53
Brandon Westman Harvest	56
Trapshooting Coaches of Manitoba	60
Manitoba Provincial 2010 Allstars and Teams	62
Manitoba Regional Team Competition	63
Manitoba Provincial 16 Yard Champions.....	64
Manitoba Provincial Handicap Champions.....	65
Manitoba Provincial Double Champions	66
Manitoba Provincial Junior Champions	67
Manitoba Provincial Ladies & Sub-Junior Champions.....	68
Manitoba Provincial Veteran and Senior Veteran Champions.....	69
Manitoba Provincial All-Around Champions.....	70
List of Advertisers.....	72



President's Message

I would like to wish all the shooters a great 2011 target season. Hopefully the weather will be better than it was last year.

Congratulations to Patrick Lamont, Robert Lamont, Brian Johnson, Larry Desjarlais and Rodney Stuart for making the Manitoba Provincial 2010 1st place All Star Team.

Victoria Jones made the Ladies All Star Team with a overall score of 88.07. She was also the High A.T.A. Average Lady shooter with a overall score of 88.67. Trevor Lewarton received High A.T.A. Average for Junior with a score of 96.25.

The Portage Plains Gun Club will be hosting the Manitoba Provincial Championships July 8, 9 and 10, 2011.

The MJSA Junior Championships will be held on June 26, 2011 at the Pembina Triangle Gun Club.

For those who like things a little faster, Winnipeg Trap and Skeet Club will be hosting the International Trap Provincials August 6 & 7, 2011.

Best of luck to all shooters in 2011.

Jim Turner
President



Manitoba Trapshooting Association Update

There have been a number of inquires over the past couple of years as to funding for travel to Trap Shoots outside of Manitoba. There was a blurb in the fall newsletter but I thought that if the information is in this booklet then everyone can read it again.

The funding for all programs comes from Sport Manitoba. In order to get funding the MTA board must submit a plan for how the funding will be spent a year in advance. All spending must fit into Sport Manitoba's criteria to be approved.

Our programs provide for two levels of assistance:

The first is from the MTA and assists the Manitoba Provincial Champion of Singles, Handicap, and Doubles to train and attend Canadian and World Championship events. If the champion cannot attend then consideration will be given to runner-ups, class winners and possibly the 1st All Star Team. The amount available will depend on funds available and number of athletes requesting assistance. The funding is on the basis of the decision of the Board of Directors of the MTA. All athletes must complete and sign the athlete assistance form and submit it to the Secretary/Treasurer by September 1st of the current year.

The second level of funding is from Sport Manitoba. This funding is for Provincial Champions only, who attend either the Canadian or World Championships. Sport Manitoba requires that the athletes place in the top 10% or top 10 at the national or international championships. Some latitude is given in the case of Juniors and Sub-Juniors to attend other championships. Champions are asked to report scores & placing to the secretary/treasurer of the MTA and will be sent a Sport Manitoba Form for completion. This form must be filled in and returned to the secretary of the MTA (to be signed) then forwarded to Sport Manitoba for consideration.

I hope this clarifies some questions. Best of luck in the 2011 season.

Kevin Brown
Past President

Manitoba 2011 Trapshooting Schedule

<i>DATE</i>	<i>LOCATION</i>	<i>NAME</i>
May 29	Winnipeg	Winnipeg Open
June 4-5	Brandon	Westman Open
June 11-12	Winnipeg	International Trap
June 25	Pembina	Mid-Summer
June 26	Pembina	Junior Provincial
July 8-10	Portage la Prairie	MTA Provincial
July 23-24	Winnipeg	Grand Alternative
August 6-7	Winnipeg	International Trap Provincial
August 14	Lundar	
August 20-21	Pembina	
August 27-28	Brandon	Westman Harvest

MAJOR OUT-OF-PROVINCE SHOOTS

June 30 - July 2	Walsh County	
July 31 - August 1	South Dakota	Central Zone
August 3-13	Sparta, Illinois	Grand American

Shooter's Responsibility

1. All shooters participating in any part of the program must have their current ATA average card.
2. All scores must be posted on the card and averages figured and up-to-date, before presenting it to the classification committee. The committee may reject any card not up-to-date.
3. Be certain, once entry is made, it is final. NO additions or with drawl will be allowed after the event is started.
4. Watch the boards and be ready to compete when your squads called to the firing line. There will be no waiting for tardy shooters.
5. If you miss your squad, you may make up to 50 targets on the practice trap at the committee's discretion, otherwise report to the office and you will be re-squadded in the last squad if time permits.
6. No scores will be recorded if they are shot in any squad other than the one assigned by the office.
7. Check scores after each post shot and be certain that they are correct before firing at a target at the next post.
8. Only errors in addition may be corrected after a score sheet leaves the trap.
9. Conduct yourself in accordance with ATA rules at all times.
10. Double check your entry cards, be certain of your class and yardage. It is the responsibility of Ladies, Veterans, Senior Veterans, Juniors and Sub-Juniors to see that they are properly entered on their cards and the bulletin sheets. Report any errors or omissions on the bulletin sheets to the cashier and score board attendants.
11. If you win or tie for a class or win yardage, report to the classification committee and have your card updated. Reclassifications and earned yardage will be posted on the score board, be certain to check, it is the shooter's responsibility to be in correct class and shoot the correct yardage.

Respect in Sport Policy

1. The Manitoba Trapshooting Association Inc. is committed to creating a sport environment in which all individuals are treated with respect and dignity. Coaches have a responsibility to create a sporting environment that is free of harassment and abuse.
2. The Manitoba Trapshooting Association Inc. requires that all coaches participating in trapshooting have completed the online “Respect in Sport” as required by Sports Manitoba.

Scope and Application

1. The policy applies to all coaches registered with; or named on a official sport roster; or under the jurisdiction of the Manitoba Trapshooting Association Inc.
2. Any coach not having completed the program or maintained certified status in the timeframe established by the Manitoba Trapshooting Association Inc. may be removed as a coach until such time that the course is completed.
3. The Board of Directors of Manitoba Trapshooting Association Inc. is responsible for setting out the communication and timing of course completion and recertification.

Enforcement

Non-compliance of this policy may result in further discipline as determined by the Board of Directors or in accordance with Manitoba Trapshooting Association Inc. Policy.

Review and Policy

This policy was approved by the Board of Directors on October 31, 2010 and will be reviewed by the executive committee on an annual basis.



Classification for all Manitoba Trap Clubs

SINGLES

AA	97 and over
A	94 and under 97
B	91 and under 94
C	88 and under 91
D	under 88
Lady A	85 and over
Lady B	under 85
Sub-Junior	under 15 years of age
Junior	15 years and under 18
Veteran	65 and under 70
Sr. Veteran	70 years and over

DOUBLES

Regular Shoots

Four Classes

A	90 and over
B	85 and over
C	78 and over
D	under 78

Provincial Shoot

Five Classes

AA	93 and over
A	89 and under 93
B	85 and under 89
C	78 and under 85
D	under 78

HANDICAP

Champion
2nd Runner-Up
3rd Runner-Up

NOTE:

1. Winners do not advance in class, except in "Handicap"
2. It is the responsibility of the shooter to have his/her average card up-to-date prior to registration.

2011 Saskatchewan Registered Shoots and Meeting Dates

April 10	SATA Spring Meeting - Regina
April 23 & 24	available shoot date
April 30 & May 1	available shoot date
May 6, 7 & 8	The Gun Club, Allan, SK
May 13, 14 & 15	Lloydminster Trap Club, Lloydminster, SK
May 20, 21 & 22	The Lone Pine Gun Club, Outlook, SK
May 27, 28 & 29	Estevan Trap Club, Estevan, SK
June 3, 4 & 5	Bear Hills Range & Gun Club, Biggar, SK
June 5 to 12	Canadian International Trap Championships Toronto International Trap & Skeet Club, Cookstown, ON
June 10, 11 & 12	Macklin Gun Club, Macklin, SK
June 17, 18 & 19	Preeceville Trap Shooting Club, Preeceville, SK
June 24, 25 & 26	Saskatoon Gun Club, Saskatoon, SK
June 29 & 30	56th Canadian Trap Championships
July 1, 2 & 3	St. Thomas Gun Club, St. Thomas, Ontario
July 8, 9 & 10	Macklin Gun Club, Macklin, SK
July 8, 9 & 10	2011 Manitoba Provincial Championships Portage Plains Gun Club, Portage la Prairie, Manitoba
July 14, 15, 16 & 17	2011 Saskatchewan Trap Shooting Championships Regina Trap & Skeet Club – Regina, SK
July 16	SATA Provincial Meeting – Regina Trap & Skeet Club
July 20, 21, 22, 23 & 24	2011 Alberta Provincial Championships Edmonton Gun Club, Edmonton, Alberta
July 22, 23 & 24	Saskatoon Gun Club, Saskatoon, SK
July 29, 30 & 31	Regina Trap & Skeet Club, Regina, SK

Saskatchewan dates, continued

July 29, 30, 31 & August 1	Central Zone Shoot – Capital City Gun Club Bismarck, North Dakota
July 29, 30, 31 & August 1	Saskatchewan International Trap Championships Saskatoon Gun Club, Saskatoon, SK
August 3 to 13	112 th Grand American – Sparta, Illinois World Shooting & Recreational Complex
August 5, 6 & 7	Preeceville Trap Shooting Club, Preeceville, SK
August 12, 13 & 14	Swift Current Trap Club, Swift Current, SK
August 19, 20 & 21	Churchbridge Trap Club, Churchbridge, SK
August 26, 27 & 28	The Gun Club, Allan, SK

*2011 Target year ends on August 31, 2011 – 2012
Target year begins on Sept. 1, 2011*

September 2, 3 & 4	available shoot date
September 9, 10 & 11	30th Hooty Owl Shoot, Yorkton Gun Club
September 17	<i>All 2011 SATA All Star & Travel Grant forms must be postmarked by this date – no exceptions</i>
September 16 & 17	The Gun Club, Allan, SK (Friday & Saturday)
September 18	SATA Fall Director's Meeting on Sunday – Saskatoon
September 25	Churchbridge Trap Club – National Trapshooting Day Shoot
January 28, 2012	SATA AGM for 2012 – Saskatoon

General Information for all Manitoba Trap Clubs

- 1. LADIES (Manitoba residents only)**
Not participating in any purse or options or playing any money may shoot for 50% per 100 targets in any event. Membership in the A.T.A. is a requirement and is the shooter's responsibility.
- 2. JUNIORS and SUB-JUNIORS (Manitoba residents only)**
Not participating in any purse or options or playing any money may shoot for 50% per 100 targets in any event. Membership in the A.T.A. is a requirement and is the shooter's responsibility.
- 3. NOVICE SHOOTERS (Manitoba residents only)**
Will have their first 100 registered targets paid for by the M.T.A. (including daily fees). A.T.A. membership is a requirement and is the shooter's responsibility. Thereafter, novices will have registered targets reduced by 50% until August 31st.
- 4. LADIES, JUNIORS, SUB-JUNIORS, VETERANS and SENIOR VETERANS**
Will be eligible only for the respective trophies provided for them unless at the time of entry they declare that they are shooting for class trophies, at which point they will forfeit all rights to special trophies except as provided by A.T.A. at state or zone shoots.
- 5. CLUB**
The host club reserves the right to amend the published program as it sees fit. All changes must be posted on the club grounds at the squadding table.
- 6. AMMUNITION**
Limited supplies of factory ammunition may be available at the club. Reloads conforming to A.T.A. rules and regulations are permitted. Please leave your empties where they fall while shooting.
- 7. ACCIDENTS and THEFT**
The host club, M.T.A. and Sport Manitoba do not assume responsibility for accidents or loss of property.
- 8. A.T.A. / I.S.S.E.**
Rules govern all shoots where applicable.
- 9. TRAILER PARKING**
Trailer parking with electrical hookups are available at most clubs. Please call to check. Drinking water and washrooms will be made available. Donations are gratefully accepted.
- 10. U.S. EXCHANGE**
U.S. exchange is provided by all clubs. Rate of exchange will be based on current bank rate.
- 11. FOOD SERVICES**
Food services available at all clubs.
- 12. ALCOHOL**
Alcohol is not permitted on grounds unless in clubhouse or campers.
- 13. CALCUTTA**
Buyers 70% / Shooters 30% (1 for 7 high gun). "All money paid out."

Manitoba Trap Association 2011 Board of Directors

The Board of Directors of the Manitoba Trap Shooting Association is made up with representation from the four major clubs in Manitoba.

PRESIDENT	JIM TURNER	Ph. (204) 239-0325	PORTAGE
VICE-PRESIDENT	CARL FRIESEN	Ph. (204) 725-4757	BRANDON
SECRETARY / TREASURER	DON SMITH	Ph. (204) 325-4868	WINKLER
PAST PRESIDENT	KEVIN BROWN	Ph. (204) 343-2270	PEMBINA
DIRECTOR	PAUL ADDRIANSON	Ph. (204) 834-3398	BRANDON
DIRECTOR	LORNE ROSS	Ph. (204) 941-0708	LUNDAR
DIRECTOR	KEVIN BROWN	Ph. (204) 343-2370	PEMBINA
DIRECTOR	VERN REMPEL	Ph. (204) 888-5601	PEMBINA
DIRECTOR	PAUL MARTIN	Ph. (204) 857-3594	PORTAGE
DIRECTOR	JIM TURNER	Ph. (204) 239-0325	PORTAGE
DIRECTOR	LOUISE CURÉ	Ph. (204) 831-1850	WINNIPEG
DIRECTOR	GERRI GEROW	Ph. (204) 889-7400	WINNIPEG
DIRECTOR	DAVID MOSSCROP	Ph. (204) 475-7045	WINNIPEG
A.T.A. DELEGATE	ROBERT LAMONT	Ph. (204) 727-3552	BRANDON
C.T.A. DELEGATE	CARL FRIESEN	Ph. (204) 725-4757	BRANDON

BOARD OF DIRECTORS MEETINGS

The M.T.A. Board of Directors meetings are held throughout the year at a central location in order so that all Directors can attend. The Directors carry out the business of the Association for the benefit of the members and trapshooting in Manitoba.

The Semi-Annual meeting is open to any member in good standing and who is a member of a M.T.A. affiliated club. The meetings will take place at the Manitoba Provincial Championships.

Affiliated Manitoba Trap Clubs and Directors

BRANDON GUN CLUB

Patrick Lamont	President	(204) 728-4884
Robert Lamont	Treasurer	(204) 727-3552
Linda Hoy	Secretary	(204)727-3552

PEMBINA TRIANGLE TRAP CLUB INC.

Vern Rempel	President	(204) 888-5601
Don Smith	Treasurer	(204) 325-4868
Kevin Brown	Secretary	(204) 343-2270

PORTAGE PLAINS GUN CLUB INC.

Paul Martin	President	(204) 857-9857
Jim Turner	Secretary/Treasurer	(204) 239-0325

WINNIPEG TRAP AND SKEET CLUB INC.

Ken Wight	President	(204) 612-9055
Scott Masniuk	Secretary/Treasurer	(204) 223-5647
Louise Curé	Trap Director	(204) 831-1850

OTHER TRAP CLUBS IN MANITOBA

Ashern Gun Club	Lundar Trap Club
Birtle Trap Club	Reston Trap Club
Flin Flon/Creighton Trap Club	Snow Lake Gun Club
Parkland Trap Club	St. Hubertus Wildlife and Trap Club Inc.
Swan River Trap Club	

Attention:

Should other trap clubs exist, please notify
one of the Board of Directors
at the Manitoba Trapshooting Association Inc

Manitoba Trapshooting Hall of Honor

		Inducted
John Masniuk	Winnipeg Trap and Skeet Club	2008
George Gerow	Winnipeg Trap and Skeet Club	2006
Floyd Rawlings	Portage Plains Gun Club	2003
Sylvia Rawlings	Portage Plains Gun Club	2003
George Kontzamanis	Winnipeg Trap and Skeet Club	2002
Henry Hlady	Brandon Gun Club	2000
Merv Moxley	Winnipeg Trap and Skeet Club	1999
Emma Moxley	Winnipeg Trap and Skeet Club	1999
Orville Minish	Swan River Gun Club	1998
Bruce Bower	Winnipeg Trap and Skeet Club	1998
Robert Avery	Rock Lake Gun Club	1995
Tryggvi Johnson	Rock Lake Gun Club	1992
Howie Gibbs	Brandon Gun Club	1989
Claude Grayson	Rock Lake Gun Club	1981
Archie Street	Portage Plains Gun Club	1980
Bob Hamilton	Winnipeg Trap and Skeet Club	1979
Al Smith	Winnipeg Trap and Skeet Club	1978
Jeff Avery	Rock Lake Gun Club	1978
Fred Mansoff	Brandon Gun Club	1977
E. E. (Kip) Kipling	Brandon Gun Club	1977
H. T. (Hank) Gardiner	Brandon Gun Club	1976
W. J. (Bill) Campbell	Winnipeg Trap and Skeet Club	1975
H. T. (Harry) Simpson	Winnipeg Trap and Skeet Club	1975
Jim C. Collingwood	Brandon Gun Club	1975
Tom Brodie	Winnipeg Trap and Skeet Club	
Johnny Black	Winnipeg Trap and Skeet Club	
Tom Harland	Winnipeg Trap and Skeet Club	
Chummy Plummer	Flin Flon	
Mrs. C. Plummer	Flin Flon	
Bert Brodie	Winnipeg Trap and Skeet Club	
Joe Cadham	Winnipeg Trap and Skeet Club	
Joe Avery	Rock Lake Gun Club	

HALL OF FAME

Patrick Lamont	Brandon Gun Club	2010
Robert Lamont	Brandon Gun Club	2006
Stan Orr	Winnipeg Trap and Skeet Club	2000
Larry Wah	Winnipeg Trap and Skeet Club	2000
Bruce Kent	Brandon Gun Club	1981

PROCEDURE

1. Any five members of the Manitoba Trapshooting Association in good standing may nominate a candidate to the Hall of Honor.
2. Written description of the candidate's career and achievements is required, along with their reasons for recommendation.
3. Nominations are to be sent to the MTA for consideration no later than November 30th of the year preceding induction.
4. All nominations shall be reviewed by the Board of Directors of the MTA. The Board's decision is final.



**Best of Luck to all Shooters
in 2011**

HAVE FUN AND BE SAFE

*Your **FRST** choice*

**SEE YOUR LOCAL SUBWAY
FOR ALL OF YOUR CATERING NEEDS
OR CALL 888-SUBS**

Andy Johnston

All The Best to all Our Friends
Kontzamanis Family

Papa George's



Delivery / Take out / Family Dining
Fully Licenced

“Famous” in Winnipeg For:

- Pizza Pasta Chicken
- Salads Ribs Hamburgers
- Seafood Low Calorie Dishes
- Steaks Late Night Snacks

& Delicious Greek Dishes

- Party Smorgasbord 10-200 People

Open Until 4 am

Sundays & Holidays until 1:30 pm

*Located in the Heart of Osborne Village
at River and Osborne*



(204) 452-6044

(Free delivery on Pizzas and Dinners, starting at 5:00 pm)



Winnipeg Trap and Skeet Club Inc.

Winnipeg Open

Sunday, May 29, 2011

Registration: 9:00 a.m.

Shooting: 10:00 a.m.

EVENT #1 100 16-Yard Targets

Targets..... \$25.00
M.T.A. / A.T.A. Daily Fees \$7.00
Buddy Wild Card (50/30/20) \$5.00
Trophies: A, B, C, D, Ladies, Junior, Sub-Junior

EVENT #2 100 Handicap

Targets..... \$25.00
M.T.A. / A.T.A. Daily Fees \$7.00
Buddy Wild Card (50/30/20) \$5.00
Trophies: A, B, C, D, Ladies, Junior, Sub-Junior

EVENT #3 50 Pair Doubles

Targets..... \$25.00
M.T.A. / A.T.A. Daily Fees \$7.00
Buddy Wild Card (50/30/20) \$5.00
Trophies: A, B, C, D, Ladies, Junior, Sub-Junior

**Note: Trophies or Cash Awards are available for Classes A, B, C, D
(\$5.00 per 100)**

CANTEEN OPEN FOR BREAKFAST AND LUNCH

ATTENTION: Winnipeg teams to be based on the top 5 scores
from Saturday or Sunday events

Club ☎ (204) 736-2779

website: <http://winnipegtrapandskeet.com>



Youth Trapshooting

WINNIPEG TRAP AND SKEET CLUB Youth Mentor Programs 2011

Junior Trap Shooting

Mondays 5:30 PM till Dark
May until end of June

Junior Skeet Shooting

Wednesdays 5:30 PM till Dark
May until end of June

Season wind-ups for all Juniors includes food,
fun shooting & prizes last week of June.

Contact: Lorne Ross, Junior Trap Coach MTA Jrs.

Tel: 204.467.2267 or cell 204.941.0708
rosslorne@hotmail.com

Brian Konrad, Youth Mentor

Tel: 489-4640 or 1-888-205-4828 ext 246
winnipegtrapandskeet@yahoo.com

*The WTSC is located 4km south west of Oak Bluff
(just past the Perimeter) on Highway #3 West.*

Tel: 1-204-736-2779

Website: winnipegtrapandskeet.com

We want your business in Brandon



COLONIAL INN

- 87 Air-Conditioned Rooms
- Indoor Pool and Whirlpool
- Great Restaurant—open at 6 a.m.
- Cable TV (TSN, CNN, etc.)
- Walk to Keystone Centre and Malls
- Plenty of Parking
- Videos available

CALL TOLL-FREE 1-800-665-6373

www.colonialinn.mb.ca

1944 QUEENS AVENUE, BRANDON



REDWOOD MOTOR INN



Toll Free: 1-877-728-2200

- 60 Air conditioned rooms
- Indoor pool and whirlpool
- Complimentary breakfast
- Cable TV plus movie central
- Vendor
- All main floor rooms with inside & outside entrances
- Plenty of parking

Coming soon we will have a restaurant and lounge

345-18th Street North

Brandon, Manitoba

Tel: 728-200 Fax: 725-4758

Website: www.redwoodinn.mb.ca

Good Luck Shooters

from Paul & Kim

SPUD PLAINS
FARMS LTD.



WELLWOOD,
MANITOBA

BRANDON GUN CLUB

Westman Open

Saturday, June 4, 2011

Registration: 9:00 a.m. Shooting: 10:00 a.m.

Location: 2 miles south on #10 Hwy.

EVENT #1 100 16-Yard Targets

Targets.....\$25.00
M.T.A. / A.T.A. Daily Fees\$7.00
Buddy Wild Card (50/30/20)\$5.00

EVENT #2 100 Handicap Targets

Targets.....\$25.00
M.T.A. / A.T.A. Daily Fees\$7.00
Buddy Wild Card (50/30/20)\$5.00

EVENT #3 50 Pair Doubles

Targets.....\$25.00
M.T.A. / A.T.A. Daily Fees\$7.00
Buddy Wild Card (50/30/20)\$5.00

CANTEEN OPEN BREAKFAST & LUNCH

ATTENTION: WESTMAN REGIONAL SHOOTERS

Westman Teams to be based on the top 5 scores
from Saturday or Sunday events

**For more information call:
Brandon Gun Club 204-728-4884**

BRANDON GUN CLUB

Westman Open

Sunday, June 5, 2011

Registration: 9:00 a.m. Shooting: 10:00 a.m.

Location: 2 miles south on #10 Hwy.

EVENT #1 100 16-Yard Targets

Targets.....\$25.00
M.T.A. / A.T.A. Daily Fees\$7.00
Buddy Wild Card (50/30/20)\$5.00

EVENT #2 100 Handicap Targets

Targets.....\$25.00
M.T.A. / A.T.A. Daily Fees\$7.00
Buddy Wild Card (50/30/20)\$5.00

EVENT #3 50 Pair Doubles

Targets.....\$25.00
M.T.A. / A.T.A. Daily Fees\$7.00
Buddy Wild Card (50/30/20)\$5.00

CANTEEN OPEN BREAKFAST & LUNCH

ATTENTION: WESTMAN REGIONAL SHOOTERS

Westman Teams to be based on the top 5 scores
from Saturday or Sunday events

**For more information call:
Brandon Gun Club 204-728-4884**



727-1422 • toll-free 1-888-33-CANAD • www.canadinns.com

PACKED WITH FUN!

- Splasher's Indoor Pool and Waterslide
- AALTOS Garden Cafe, Tavern United and The Great Western Roadhouse
- Playmaker's Gaming Lounge and Piano Bar
- Directly connected to the Keystone Centre

Canad Inns Destination Centre Brandon
 1125 - 18th Street
 Brandon, MB



Your Destination Centres

canadinns.com

1-888-33-CANAD



A PET LOVER'S WAREHOUSE LTD.

COMPLETE LINE OF PET PRODUCTS

WHOLESALE OR RETAIL

All the best

in 2011

Rob & Pat Lamont

2324 PARK AVENUE, BRANDON, MANITOBA

Telephone (204) 725-1172

Fax (204) 725-1173

THE WOOD JOYNT LTD.

STOCKING DEALER FOR THE FOLLOWING
PRODUCTS

DILLON PRECISION
BERRYS BULLETS
HS PRECISION
SCORE
STI
GLOCK
CZ
TANFOGLIO
LEUPOLD
ARMALITE RIFLES
XCR RIFLES
SKS
CZ 858

CARRYING A FULL LINE OF POWDERS, PRIMERS
AND OTHER RELOADING COMPONENTS
ALL OTHER MAKES OF FIREARMS AVAILABLE
ON
REQUEST
ALL KINDS OF AMMUNITION
FIREARMS ACCESSORIES

**CONTACT BILL KLEIN
312 RICHMOND AVENUE EAST
BRANDON, MB R7A 7G3**

**PH: 204-729-0625
FAX: 204-726-4462
CELL: 204-724-4065**



Home hardware building centre

- Remington
- Ruger
- Savage
- Mossberg
- Maverick
- New England Fire-arms
- Traditions
- Thompson Center
- Tikka
- Sako
- CZ
- Marlin
- Henry
- Benelli
- Stoeger
- Browning
- Glock
- Walther
- Para Ordnance
- Heckler & Koch
- Umarex
- PPU
- Federal
- Winchester
- Hornady
- CCI
- Remington
- Norma
- Bulk Surplus
Ammunition
- Game Calls
- Reloading Supplies
- Licencing

WE'VE GOT YOUR LUMBER

1020 - 18th Street
Brandon, MB
R7A 5C1

Phone: 204-728-2230
Fax: 204-727-8633
Toll Free: 1-877-723-2837

International Trap

Winnipeg Trap and Skeet Club is an outstanding shooting facility, unmatched in Canada.
Only 2 other clubs have two Olympic bunkers.

This year there will be two opportunities to compete in Olympic Trap in the Province:
June 11 & 12 Fun shoot
and
August 6 & 7 Provincials

The WTSC bunker facility will be open every Tuesday, Thursday and Sunday during the summer months for practice or by appointment.

Members and Guests are \$6.00 per round,
Non-members are \$10.00
Members of MTA affiliated club shoot for members pricing.

MTA *'Try-it you'll like it'* program in effect for new shooters

Instruction available.

Quality White Flyer targets will be thrown
and the table changed weekly.

24 gram Ammunition will be available from the club



<http://winnipegtrapandskeet.com>



 **International Trap** 

**Fun shoot
Saturday, & Sunday
June 11 & 12, 2011**

**Winnipeg Trap and Skeet Club will host a
fun shoot in International Trap**

**Registration starts at 9:00 a.m.
Events start at 10:00 a.m.
Saturday 125 single targets (\$45.00)
Sunday 75 pairs double targets (\$40.00)**

*International Class:
24 gram or 7/8 oz lead shot, no larger than 7 1/2, Over-unders only.
Hunter class:
12 ga and sub gauges, any target ammunition.*

Canteen available for lunch.



<http://winnipegtrapandskeet.com>



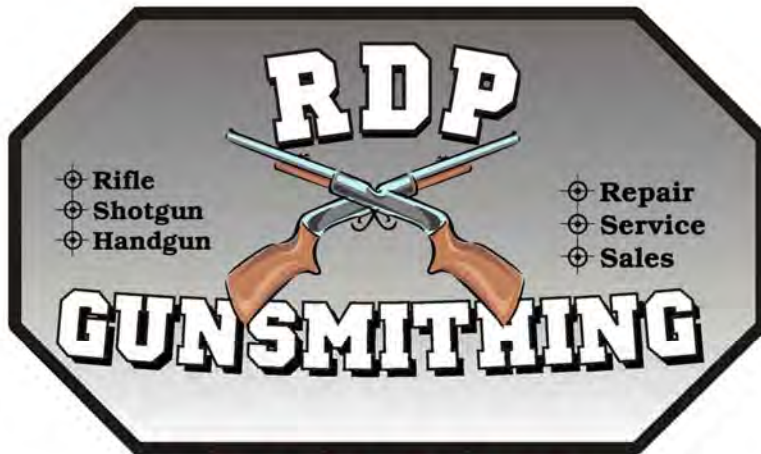

Ph: (204) 853-7585

Dugald, MB R0E 0K0
rdpgunsmith@mts.net



- ⊕ **Canadian Firearms Safety Instructor**
- ⊕ **Manitoba Wildlife Hunter Safety Instructor**

We now offer:

- ⊕ **Instruction for the Canadian Firearms Safety courses**
- ⊕ **The Manitoba Wildlife Federation Hunter Safety course**

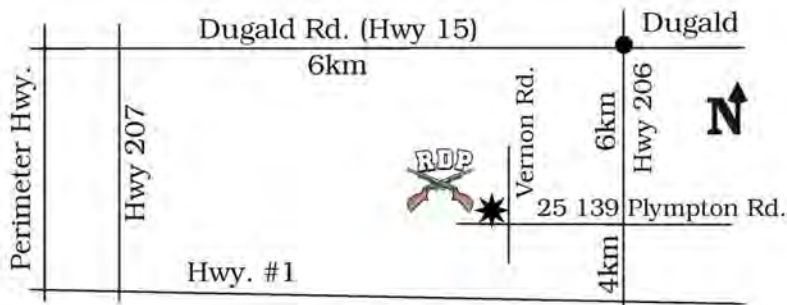

How to Keep An Average Card

When you join the A.T.A. you will receive an Average Card.

Date	Place	SGLS	Average	Class	W/T		HDCP	DBLS	Average	Class	W/T	
					W	T					W	T
6-8	Pembina	98	.9800	B			91	85	.8500	D		
6-9	Pembina	94	.9600	A			86	89	.8700	D		
6-10	Pembina	190	.9550	A								

↑
start date

↑
gun club

↑
singles score

↑
singles average

↑
class you shot in

↑
your score was tied in

↑
HDCP score

↑
doubles score

↑
doubles average

↑
class you shot in

↑
your score won

- Keeping this card neat and up-to-date at all times is your responsibility.
- The card must be presented at the time of registration at your next shoot.
- Blank cards are available at each of the major Clubs for new competitors who have not received their first card.

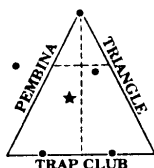

Pembina Triangle Trap Club Inc. Summer's Here Now

Saturday, June 25, 2011

Registration: 9:00 a.m. Shooting: 10:00 a.m.

Location: between Carman and Morden
6 1/2 km south of junction #23 and #3 and 1 km west.

EVENT #1 100 16-Yard Targets

Targets.....\$23.00
M.T.A. / A.T.A. Daily Fees\$7.00
Buddy Wild Card (50/30/20)\$5.00
\$23.00 Targets in lieu of trophies

EVENT #2 100 Handicap

Targets.....\$23.00
M.T.A. / A.T.A. Daily Fees\$7.00
Buddy Wild Card (50/30/20)\$5.00
\$23.00 Targets in lieu of trophies

EVENT #3 50 Pair Doubles

Targets.....\$23.00
M.T.A. / A.T.A. Daily Fees\$7.00
Buddy Wildcard (50/30/20)\$5.00
\$23.00 Targets in lieu of trophies

CANTEEN OPEN

ATTENTION: Pembina Triangle teams to be based on the top 5 scores from Saturday or Sunday events

For more information, call:

Kevin Brown *or* **Don Smith**
(204) 343-2270 **(204) 325-4868**
ksbrown@snet.ca **donsmith@mts.net**

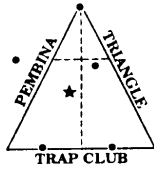

Pembina Triangle Trap Club Inc.

**Manitoba Junior
Shotgun Association**

Provincial Championship

Sunday, June 26, 2011

Registration: 9:00 a.m. Shooting: 10:00 a.m.

Location: between Carman and Morden
6 1/2 km south of junction #23 and #3 and 1 km west.

ENTRY FEE: \$50.00 or sale of a complete book of tickets for the MJSR Raffle (to be drawn at end of shoot). Lottery #2-2010

NOTE: Entry fee includes:

- Lunch
- 100 targets
- 4 boxes of shells
- ATA membership
- Trophies

There will be three age groups for boys and girls with Open and Closed classes in each group:

- 13 and under
- 15 and under
- 18 and under

To be eligible, a shooter must not have reached his/her 18th birthday by August 31, 2010. Shooters are classified according to their age at the date of the shoot.

Top five Junior Shooters will be sponsored to the Manitoba Provincial Trap Shoot at Portage la Prairie, July 9, 2011.



MacDonald's

Sporting Goods Ltd.

Your Hunting & Fishing Headquarters

- Wholesaler/retailer of guns
- Hunting & fishing accessories
- Ammunition
- Archery equipment
- Black Power
- Clothing
- Licences
- Distributor of Brno firearms

Open 7 Days a Week

We take trades and buy used firearms

**246 Saskatchewan Avenue, East
Portage la Prairie, MB R1N 0K9**

PH. (204) 857-3496 FAX: (204) 239-6020



Specializing in:

***Corn, Wheat, Soymeal, Soybeans
Soy oil, Barley, Rye, Flax, Canola, Sunflowers
Oats (feeding and milling)**

***Agents of the CWB**

***Licensed and bonded**

5 LOCATIONS to serve you!



Jordan Mills

“Naturally Better!”

Head Office—Winkler

(888) 974-7246

Jordan Elevator

(204) 343-2323

Gladstone Elevator

(204) 385-2292

Somerset Elevator

(204) 744-2126

Sperling Elevator

(204) 626-3261

****SERVICE WITH INTEGRITY****

WWW.DELMARCOMMODITIES.COM

TOLL FREE ~ 888-974-7246

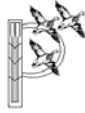

Portage Plains Gun Club

hosts the 2011

**Manitoba Trapshooting Association
Provincial Championships**

July 8, 9 and 10, 2011

Registration: 9:00 a.m. Shooting: 10:00 a.m.

EVENT #1 100 16-Yard A.T.A. Class Championship

Targets.....\$28.00
A.T.A. \$3.00 / MTA \$4.00 Fees\$7.00
Class Purse\$10.00

EVENT #2 100 Preliminary Handicap Targets

Targets.....\$28.00
A.T.A. \$3.00 / MTA \$4.00 Fees\$7.00
Class Purse (Divided 1 for 5 High Gun).....\$10.00
Option 2 50s (50/30/20 Ties Divide)\$10.00

EVENT #3 50 Pair Doubles ATA Class Championship

Targets.....\$28.00
A.T.A. \$3.00 / MTA \$4.00 Fees\$7.00
Class Purse (Divided 1 for 5 High Gun).....\$10.00

**Friday Night Supper Hosted by the Club
for all Shooters and their Families**

CANTEEN OPEN FOR BREAKFAST AND LUNCH

For more information, call:

**Portage Plains Gun Club
Phone (204) 239-0325**

Location: 7 km south of Portage on Yellow Quill Trail



Portage Plains Gun Club

hosts the 2011

**Manitoba Trapshooting Association
Provincial Championships**

Saturday, July 9, 2011

****** \$500.00 ADDED MONEY ******

Registration: 9:00 a.m. Shooting: 10:00 a.m.

EVENT #4 Manitoba Singles Championship

Targets (200 16-Yard Targets).....	\$56.00
A.T.A. \$3.00 / MTA \$4.00 Fees	\$7.00
Class Purse: AA, A, B, C, D (divided 1 for 5 High Gun).....	\$10.00

**Provincial Banquet
7:00 p.m. at the Club**

**Trophy Presentation
and
Calcutta Auction**



CANTEEN OPEN FOR BREAKFAST AND LUNCH

For more information, call:

Portage Plains Gun Club

Phone (204) 239-0325

Location: 7 km south of Portage on Yellow Quill Trail

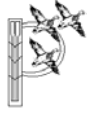

Portage Plains Gun Club

hosts the 2011

Manitoba Trapshooting Association Provincial Championships

Sunday, July 10, 2011

**** \$500.00 ADDED MONEY ****

Registration: 9:00 a.m. Shooting: 10:00 a.m.

EVENT #5 50 — Pair Doubles

Manitoba Doubles Championship

Targets.....	\$28.00
A.T.A. /M.T.A. Daily Fees	\$7.00
Class Purse: (divided 1 for 5 High Gun).....	\$10.00
Buddy Wild Card	\$5.00
\$500.00 M.T.A. added money — \$100.00 each class 60/40 split	

EVENT #6 100 — Handcap Targets

Manitoba Handicap Championship

Targets.....	\$28.00
A.T.A. / M.T.A. Daily Fees	\$7.00
Lewis Purse: (Hall of Fame 50-50) (divided 1 for 5 High Gun).....	\$10.00
Buddy Wild Card	\$5.00
Calcutta (1 for 7 High Gun).....	\$10.00
\$100.00 M.T.A. added money — 1st to 3rd High Guns only	

Hall of Fame Contributor Award Trophy courtesy of Shamrock Leathers
A specially-created leather shell box holder
will be given to the highest scorer in Event #6 Lewis Class.

The Trapshooting Hall of Fame maintains a museum at the home grounds in Vandalia, Ohio and provides a research library for the history of our sport. It also awards college scholarships and conducts a youth program to promote the future of Trapshooting. Half of the entry in this award is donated to the Hall of Fame.

We encourage you to participate and support its various activities.

**PLEASE TURN IN SCORES AFTER EVENT No. 6
FOR ELIGIBILITY.**

Trophy Schedule: M.T.A. Provincial Championship

Event *Closed* *Open*

FRIDAY

Event No. 1 Class Championship 100 16-Yard Singles	A.T.A. - Manitoba Class Champions AA - A - B - C - D	AA - A - B - C - D
Event No. 2 100 Handcap		Champion 2nd Runner Up 3rd Runner Up
Event No. 3 Class Championship 50 Pair Doubles	A.T.A. Class Champions AA - A - B - C - D	AA - A - B - C - D

SATURDAY

Event No. 4 Singles Championship 200 16-Yard	A.T.A. - Manitoba Class Champion Runner Up Lady, Junior Sub-Junior Veteran Sr. Veteran	AA - A - B - C - D Lady A - B Junior Sub-Junior Veteran Sr. Veteran
---	--	--

SUNDAY

Event No. 5 Doubles Championship 50 - Pair Doubles	A.T.A. - Manitoba Champion Runner Up	AA - A - B - C - D
Event No. 6 Handicap Championship 100 Handicap	A.T.A. - Manitoba Champion 2nd Runner-Up 3rd to 6th Place	Champion 2nd Runner Up
High All-Around Events 4 - 5 - 6 400 Targets	A.T.A. Manitoba Champion	Champion
High Over-All Events 1-6 700 Targets		Champion AA - A - B - C - D Lady Veteran Sr. Veteran
Provincial Team Champions Events 4 - 5 - 6	Gold Medals - 16-Yard Gold Medals - Handicap Gold Medals - Doubles	



Portage la Prairie

- ✓ Great Rooms
- ✓ Aalto's Garden Cafe
- ✓ Playmakers Lounge
- ✓ Hot Tub
- ✓ Splashers Funtastic Waterslide & Kiddie Pool

For Reservations call

204-857-9745

or 1-888-33-CANAD

or online at www.canadinns.com



We're here to meet all your needs!

WESTWARD — FORD —

Hwy 1A West

Hwy 16 West

Portage la Prairie, MB

Neepawa, MB

Phone (204) 857-3912

Phone (204) 476-2391

Email: westwardford@mts.net

Web Site: www.westwardford.com

AG WEST EQUIPMENT LTD

proudly serving the farming community
of Portage la Prairie for 20 years!

Hwy 1A West
Portage la Prairie, MB
204-857-5130

Hwy 16 West
Neepawa, MB
204-476-5378

www.agwestequip.com



MASSEY FERGUSON



SPRA-COUCPE



FENDT



GLEANER
ABCO



VERSATILE



MISSION Series
by Massey Ferguson

BILL'S



STICKY FINGERS

**CHICKEN, RIBS,
STEAK & PIZZA**

FREE DELIVERY

DINE IN - TAKE OUT

LOUNGE - FULLY LICENSED

857-9999

Portage's # 1 Pizza

Ribs - Chicken - Fish & Salad

Hours

Mon. to Sat. 11 am - 12 midnight

Sunday 4 pm - 9 pm

210 Saskatchewan Ave. East



MID - PLAINS

Implements Ltd.

Carberry, MB

Box 610

ROK 0H0

Ph. (204) 834-2515

Fax: (204) 834-2580

Email: midplns@mts.net

Portage La Prairie, MB

Box 610

R1N 3B9

Ph. (204) 239-0584

Fax: (204) 239-0564



Westoba

Credit Union Ltd

First in Our Community

Your full-service financial institution!

5 ATMs for your convenience

1st and McTavish

10th and Princess

1035 Richmond Ave.

34th and Victoria

18th and Kirkcaldy (1 Indoor, 1 Drive-thru)



westoba.com

TeleService

1-877-WESTOBA

Pinegrove Gunworks

**GENERAL GUN REPAIRS
CLEANING & SERVICING**

REBUILD * REPAIR * REFINISH

**4-WAY ADJUSTABLE COMB
RECOIL REDUCERS
RECOIL PADS**

Gord_dixon@hotmail.com

**GORD DIXON 22 TETROE RD., KENORA, ONT.
PH. 807-548-5316**



Winnipeg Trap and Skeet Club Inc.

Grand Alternative

Saturday, July 23, 2011

Registration: 9:00 a.m.

Shooting: 10:00 a.m.

EVENT #1 200 16-Yard Targets

Targets.....\$50.00
M.T.A. / A.T.A. Daily Fees\$7.00
Buddy Wild Card (50/30/20)\$10.00
Trophies: A, B, C, D, Ladies, Junior, Sub-Junior

EVENT #2 100 Pair Doubles

Targets.....\$50.00
M.T.A. / A.T.A. Daily Fees\$7.00
Buddy Wild Card (50/30/20)\$10.00
Trophies: A, B, C, D, Ladies, Junior, Sub-Junior

Note: Trophies or Cash Awards are available
for Classes A, B, C, D
(\$5.00 per 100)

CANTEEN OPEN FOR BREAKFAST AND LUNCH

Club: (204) 736-2779

Website: <http://winnipegtrapandskeet.com>



Winnipeg Trap and Skeet Club Inc.

Grand Alternative

Sunday, July 24, 2011

Registration: 9:00 a.m.

Shooting: 10:00 a.m.

EVENT #3 100 16-Yard Targets

Targets.....\$25.00
M.T.A. / A.T.A. Daily Fees\$7.00
Buddy Wild Card (50/30/20)\$5.00
Trophies: A, B, C, D, Ladies, Junior, Sub-Junior

EVENT #4 Bower Memorial Handicap 200

- Handicap

Targets.....\$50.00
M.T.A. / A.T.A. Daily Fees\$7.00
Buddy Wild Card (50/30/20)\$10.00
Trophies: Champion, 2nd and 3rd

Note: Trophies or Cash Awards are available
for Classes A, B, C, D
(\$5.00 per 100)

CANTEEN OPEN FOR BREAKFAST AND LUNCH

Club: (204) 736-2779

Website: <http://winnipegtrapandskeet.com>

Amateur Trapshooting Association



Shooting Coach

Brian Konrad

PO Box 9 GRP 360 RR3
Winnipeg, MB R3C 2E7

0314712
Expiration Date: June 30, 2012

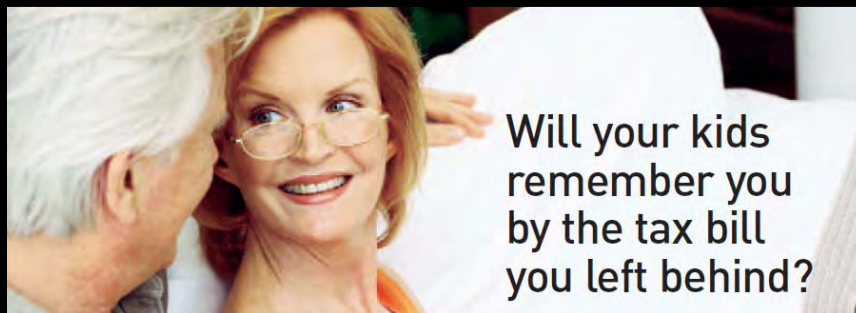

Will your kids
remember you
by the tax bill
you left behind?

Ever wonder how life insurance* could pay the taxes on your registered assets, helping to preserve the value of your estate for your loved ones? Do what you can now to be remembered for all the right reasons.

Call us to find out how The Plan™ can help you prosper now... and over time.



BRIAN G. KONRAD CFP

Financial Consultant
brian.konrad@investorsgroup.com

(204) 489-4640 ext. 246
1-888-205-4828

The Plan
by  **Investors
Group™**

Investors Group Financial Services Inc.

™Trademarks owned by IGM Financial Inc. and licensed to its subsidiary corporations.
* Insurance products and services distributed through I.G. Insurance Services Inc.
Insurance license sponsored by The Great-West Life Assurance Company.

LOCK AND LOAD SHOOTING SPORTS

204-981-6353

score
PRAIRIE SHOT LTD.



- **score**™ Brand of shotguns and ammunition
- Ten-year warranty
- Distributed and services in Manitoba
- Certified ATA Trap & Skeet instructor
- Private adult and junior or group shooting lessons
- Mentored sporting clays program
- Mentored waterfowl hunt program



Semi-Auto Shotguns

starting at \$499*

O/U Shotguns from \$649*

* GST Included. PST is Extra. PAL or FAC required.

Division of Gonor-Lockport Holdings Ltd.

Box 9 GRP 360 RR3 • Winnipeg, Manitoba R3C 2E7

*DU Canada, Delta Waterfowl and Manitoba Wildlife
Federation supporter*

\$300,000

ADDED MONEY

For the

2011 Grand American

Sparta, IL

August 3 -13, 2011



The ATA is proud to announce

LeeAnn Martin's

\$200,000

Lewis Challenge

And the return of the

\$100,000

Grand American Challenge

For details, go to www.shootata.com

 **International Trap** 

Saturday August 6, 2011

Sunday August 7, 2011

**Winnipeg Trap and Skeet Club will host the
2011 Manitoba Provincial
International Trap Championships**

Registration starts at 9:00 a.m.

Events start at 10:00 a.m.

Saturday 125 single targets (\$50.00)

25 target final for top 6

plus MTA daily fee \$4.50

Sunday 75 pairs double targets (\$45.00)

25 pair final for top 6

plus MTA daily fee \$4.50

International Class: competing for Annual Cup and place on Prov Team

24 gram or 7/8 oz lead shot, no larger than 7 1/2, Over-unders only.

Hunter class: 12 ga and sub gauges, any target ammunition.

Competing for prize money only.

MTA Purse: \$600.00 in added prize money!

International Class: \$100.00 Cup winner in singles and doubles.

*Hunter class: \$5 per competitor added to the Lewis class + \$200
in singles and doubles; Classes: A, B, C based upon first 50 targets.*

Lunch included, canteen available



ISSF

Manitoba Trap Association sponsored event



<http://winnipegtrapandskeet.com>



Manitoba Provincial Championships

Lundar Gun Club

Sunday, August 14, 2011

Registration: 9:00 a.m.

Shooting: 10:00 a.m.

EVENT #1 200 16-Yard Targets

Targets.....\$46.00
M.T.A. / A.T.A. Daily Fees\$7.00
Buddy Wild Card (50/30/20)\$5.00
Prizes for Sub-Junior and Junior only

EVENT #2 50 Pair Doubles

Targets.....\$23.00
M.T.A. / A.T.A. Daily Fees\$7.00
Buddy Wild Card (50/30/20)\$5.00
Prizes for Sub-Junior and Junior only

LIMITED CANTEEN AVAILABLE

For more information, call

Don Law

(204) 762-5519



TJ AUTO REPAIR

**Specializing in
High Performance Engine Mods**

**Phone 822-6613 Fax 822-6123
“t_j_repair@hotmail.com”**



**Perazzi is proud to support
shooting sports in Canada**

Good luck to all shooters!

Andy Johnston Jonathan Weselake

www.PerazziCanada.com

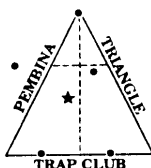

Pembina Triangle Trap Club Inc.

Saturday, August 20, 2011

Registration: 9:00 a.m. Shooting: 10:00 a.m.

Location: 8 miles north of junction #3 and #14 (Carman/Morden)

OR

4 miles south of junction #23 and #3 and 1/2 mile west.

EVENT #1 100 16-Yard Targets

Targets.....\$25.00

M.T.A. / A.T.A. Daily Fees\$7.00

Buddy Wild Card (50/30/20)\$5.00

Trophies: A, B, C, D, Lady, Novice, Junior, Sub-Junior, Vet

EVENT #2 100 Handicap

Targets.....\$25.00

M.T.A. / A.T.A. Daily Fees\$7.00

Buddy Wild Card (50/30/20)\$5.00

Trophies: 1st, 2nd, 3rd

EVENT #3 100 Handicap

Targets.....\$25.00

M.T.A. / A.T.A. Daily Fees\$7.00

Buddy Wildcard (50/30/20)\$5.00

Trophies: 1st, 2nd, 3rd

CANTEEN OPEN

For more information, call:

Kevin Brown

or

Don Smith

(204) 343-2270

(204) 325-4868

ksbrown@snet.ca

donsmith@mts.net

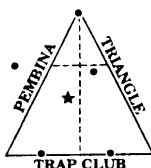

Pembina Triangle Trap Club Inc.

Doubles Day

Sunday, August 21, 2011

Registration: 9:00 a.m. Shooting: 10:00 a.m.

Location: 8 miles north of junction #3 and #14 (Carman/Morden)
OR
4 miles south of junction #23 and #3 and 1/2 mile west.

DOUBLES MARATHON

Targets.....\$25.00 / 50 Pair
M.T.A. / A.T.A. Daily Fees\$7.00
Buddy Wild Card (50/30/20) \$10.00 / 500
Trophies: A, B, C, D

CANTEEN OPEN

For more information, call:

Kevin Brown
(204) 343-2270
ksbrown@snet.ca

or

Don Smith
(204) 325-4868
donsmith@mts.net

Best wishes to all Competitors



Moonlite
Auto Body.
LTD.

www.moonlightautobody.com
420 Airport Drive, Winkler Manitoba
Ph. (204) 325-9114 Fax: (204) 325-9080

COLLISION AND GLASS EXPERTS



FAMILY RESTAURANT

OPEN MON-SAT 6 AM- 10 PM
SUNDAY 8 AM-8 PM

LOCATED IN THE CO-OP TRUCK AND TRAVEL CENTRE

Ph. (204) 331-4486

Highway #3 and #14
Box 250 WINKLER, MB. R6W 4A5

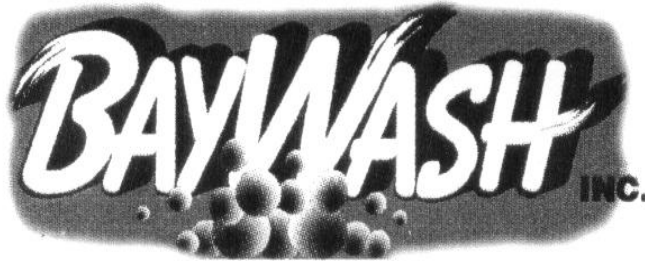

"Your Complete Auto Wash Centre"

BOB & RUTH JOHNSTON

Owners/Managers

139 Main St. N., Carman • Phone 745-2082

Good luck to all shooters!

McLaren's Metal Shop



- **Automotive/Farm Repairs**
- **Welding/Manufacturing**
- **Automotive Restorations**
- **Parts, Tires, Accessories, etc.**

Don, Shane & Clarke McLaren

Roland, Manitoba

Ph. (204) 343-2244 Fax 204-343-2273

BRANDON GUN CLUB

Westman Harvest

Saturday, August 27, 2011

Registration: 9:00 a.m. Shooting: 10:00 a.m.

Location: 2 miles south on #10 Hwy.

EVENT #1 100 16-Yard Targets

Targets.....\$25.00
M.T.A. / A.T.A. Daily Fees\$7.00
Buddy Wild Card (50/30/20)\$5.00

EVENT #2 100 Handicap Targets

Targets.....\$25.00
M.T.A. / A.T.A. Daily Fees\$7.00
Buddy Wild Card (50/30/20)\$5.00

EVENT #3 50 Pair Doubles

Targets.....\$25.00
M.T.A. / A.T.A. Daily Fees\$7.00
Buddy Wild Card (50/30/20)\$5.00

CANTEEN OPEN BREAKFAST & LUNCH

**For more information call:
Brandon Gun Club 204-728-4884**

BRANDON GUN CLUB

Westman Harvest

Sunday, August 28, 2011

Registration: 9:00 a.m. Shooting: 10:00 a.m.

Location: 2 miles south on #10 Hwy.

EVENT #1 100 16-Yard Targets

Targets.....\$25.00
M.T.A. / A.T.A. Daily Fees\$7.00
Buddy Wild Card (50/30/20)\$5.00

EVENT #2 100 Handicap Targets

Targets.....\$25.00
M.T.A. / A.T.A. Daily Fees\$7.00
Buddy Wild Card (50/30/20)\$5.00

EVENT #3 50 Pair Doubles

Targets.....\$25.00
M.T.A. / A.T.A. Daily Fees\$7.00
Buddy Wild Card (50/30/20)\$5.00

CANTEEN OPEN BREAKFAST & LUNCH

**For more information call:
Brandon Gun Club 204-728-4884**



MARTIN-LIBERTY REALTY
INDEPENDENTLY OWNED & OPERATED

BARRY GORDON
Partner/Sales Associate

Bus: (204) 725-8825
Fax: (204) 726-1378
bgordon@royallepage.ca
www.royallepage.ca

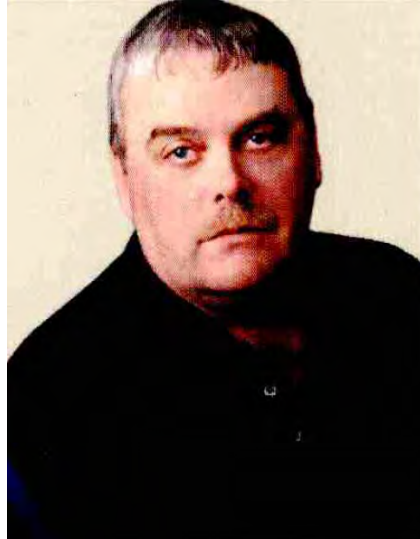

633-18th Street,
Brandon, MB R7A 5B3



SUNDAY BRUNCH IS A SURE HIT FROM 10AM - 2PM



Get it all under one roof!

OPEN FOR BREAKFAST AT 8AM

Brandon, Manitoba

18 Street South (204)727-2695

www.thunderbirdbowl.ca

CASABLANCA MOTOR INN

2728 Victoria Avenue
Brandon, MB
PH: 204-728-1500

24 Newly renovated rooms with microwave and fridge
Reasonable rates
Environmentally Friendly

The Little Chalet

18th Street and Trans-Canada Hwy
PH: 204-725-1574
Private self-contained units with microwave and fridge
Environmentally Friendly

gtp **Gislason Targownik Peters**
Certified General Accountants

Serving you between

Winkler	204-325-7579
Altona	204-324-6804
Winnipeg	204-669-4213

Trapshooting Coaches of Manitoba

The following coaches are registered with
3M-NCCP Coaching Association of Canada
and approved by Manitoba Trapshooting

Should an individual, group or club require instruction,
please feel free to contact any of the following:

Paul Adriaansen	Brandon	834-3398
Allan Aplin	Brandon	727-8137
Gerry Aplin	Brandon	727-8137
Kevin Brown	Pembina	343-2270
Kerry Coleman	Pilot Mound	873-2532
Morley Freeman	Pilot Mound	523-5620
Larry Gibbs	Portage	857-7184
William Gordon	Brandon	727-1255
Joseph Gribbon	Brandon	726-4189
Alex Gyori	Winnipeg	669-2472
Tom Hoy	Brandon	728-5675
Barry Kumka	Winnipeg	422-8492
Robert Lamont	Brandon	725-3721
Paul Martin	Portage	857-3794
Stanley Orr	Winnipeg	889-4417
Vern Rempel	Pembina	888-5601
Don Smith	Pembina	325-4868
Jim Turner	Portage	239-0325
Reg Wiebe	Portage	857-7766
Rob Wiebe	Pembina	325-8182

Trapshooting Coaches of Manitoba

The following coaches are registered with the ATA/NRA Coaching system and recognized by the Manitoba Trapshooting Association.

Should an individual, group or club require instruction, please feel free to contact any of the following for assistance.

Kevin Brown	Pembina	343-2270
Louise Curé	Winnipeg	831-1850
Harry Humby	Winnipeg	257-2483
Brian Konrad	Winnipeg	832-3360
Brian Konopski	Winnipeg	234-3414
Brian Hronimchuk	Stonewall	
Laurie Kerbrat	Ashern	768-2483
Terrell Kerbrat	Ashern	768-2453
David Mosscrop	Winnipeg	475-7045
Lorne Ross	Winnipeg	467-2267
Stacey Ross	Winnipeg	467-2267
Don Smith	Winkler	325-4868
Ken Wight	Winnipeg	257-6240



Manitoba Provincial 2010 Allstars and Teams

1st ALLSTAR TEAM

Patrick Lamont	96.02
Robert Lamont	93.61
Brian Johnson	91.3
Larry Desjarlais	90.32
Rodney Stuart	90.27

2nd ALLSTAR TEAM

Glen Morrison	89.41
Douglas Harrower	87.78
Lorne Ross	87.38
Harry Humby	86.98
Brian B. Hrominchuk	86.39

LADIES ALL STAR TEAM

Victoria Jones	88.07	Katie Jones	83.49
----------------	-------	-------------	-------

BARAGER TROPHY FOR HIGH A.T.A. AVERAGE LADY

Victoria Jones	88.67
----------------	-------

GEROW TROPHY FOR HIGH A.T.A. AVERAGE JUNIOR

Trevor Lewarton	96.25
Runnerup: Terrell Kerbrat	89.71

*To be eligible for Allstar teams in Manitoba,
competitors must shoot the minimum targets as below.*

	MEN	LADIES	JUNIORS
SINGLES	700	400	500
HANDICAP	500	200	
DOUBLES	400		

Targets shot in Manitoba registered shoots are recorded by the M.T.S. Secretary and used in Conjunction with the annual A.T.A. yearbook.

With the minimum targets shot, the A.T.A. average for each discipline will be used, and the average of the three averages will determine the final position.

Manitoba Regional Team Competition

MANITOBA SINGLES TEAM CHAMPIONS

1989	Winnipeg	943	1994	Westman	958
1990	Winnipeg	953	1995	Westman	965
1991	Winnipeg	963	1996	Westman	974
1992	Winnipeg	966	1997	Westman	969
1993	Winnipeg	976	1998	Westman	971
1999	Westman	971	2000	Westman	937
2001	Westman	976	2002	Westman	977
2003	Westman	977	2004	Westman	973
2005	Winnipeg	877	2006	Winnipeg	982
2007	Westman	973	2008	Winnipeg	907
2009	Westman	959			

GOLD MEDAL WINNERS

2009 Westman 959/1000

Rob Lamont, Pat Lamont, Paul Adriaansen, Rod Stuart, Matt Stuart

MANITOBA HANDICAP TEAM CHAMPIONS

1991	Winnipeg	437	1995	Winnipeg	437
1992	Central	465	1996	Westman	433
1993	Winnipeg	477	1997	Westman	475
1994	Westman	451	1998	Westman	444
1999	Westman	460	2000	Westman	432
2001	Westman	452	2002	Westman	462
2003	Central	448	2004	Westman	462
2005	Westman	436	2006	Interlake	461
2007	Winnipeg	454	2008	Westman	454
2009	Westman	458			

GOLD MEDAL WINNERS

2009 Westman 458/500

Matt Stuart, Rodney Stuart, Paul Adriaansen, Rob Lamont, Pat Lamont

MANITOBA DOUBLES TEAM CHAMPION

1995	Westman	455	1997	Westman	439
1996	Winnipeg	462	1998	Westman	448
1999	Westman	454	2000	Central	436
2001	Westman	449	2002	Westman	468
2003	Interlake	450	2004	Westman	465
2005	Westman	425	2006	Winnipeg	463
2007	Winnipeg	467	2008	Central	440
2009	Westman	449			

GOLD MEDAL WINNERS

2009 Westman 449/500

Pat Lamont, Rob Lamont, Paul Adriaansen, Rod Stuart, Carl Friesen

Congratulations to all Competitors and Good Luck in 2011

Manitoba Provincial Champions 16 Yard

2010	Patrick Lamont	200	1968	L. Stoyko	196
2009	Patrick Lamont	199	1967	L. Stoyko	197
2008	Bob Johnston	190	1966	W. J. Campbell	192
2007	Robert Lamont	199	1965	E. E. Kipling	181
2006	Patrick Lamont	199	1964	Bruce Kent	192
2005	Robert Lamont	192	1963	Al Smith	
2004	Patrick Lamont	199	1962	Al Smith	191
2003	Patrick Lamont	199	1961	E. E. Kipling	193
2002	Patrick Lamont	198	1960	Al Smith	
2001	Bob Johnston	199	1959	Al Smith	
2000	Glen Morrison	196	1958	Mel Cable	
1999	Larry Wah	199	1957	Al Smith	
1998	Robert Lamont	199	1956	Al Smith	
1997	Don Smith	198	1955	Ab Sole	
1996	Pat Bourns	199	1954	Al Smith	
1995	Robert Lamont	198	1953	W. Harvey	
1994	Bob Johnston	199	1952	W. Harvey	
1993	Larry Wah	198	1951	W. Harvey	
1992	Larry Wah	199	1950	Jeff Avery	
1991	Stan Orr	197	1949	S. F. Roberts	
1990	Stan Orr	197	1948	C. C. Plummer	
1989	Stan Orr	199	1947	A. E. Brodie	194
1988	Stan Orr	197	1940	A. E. Brodie	
1987	Stan Orr	197	1939	A. E. Brodie	
1986	Larry Wah	199	1938	C. C. Plummer	
1985	Alex Gyori	196	1937	A. E. Brodie	
1984	Alex Gyori	190	1936	T. Brodie	193
1983	Don Johnson	192	1935	A. E. Brodie	
1982	Stan Orr	184	1934	A. E. Brodie	
1981	Al McDonnel	196	1933	A. E. Brodie	
1980	Joy Rands	195	1932	Jeff Avery	
1979	Bruce Kent	199	1931	Dr. W. Tinsdale	
1978	Larry Wah	195	1930	A. E. Brodie	
1977	Joy Warren	196	1929	T. M. Harland	
1976	Norm Baldwin	199	1928	Joe Avery	
1975	George McCabe	197	1927	Joe Avery	
1974	Larry Wah	194	1926	Joe Avery	
1973	Trigg Johnson	193	1925	T. M. Harland	
1972	Gary Ridge	194	1924	J. Maitland	
1971	W. J. Campbell	195	1923	W. M. Geatros	
1970	Bruce Kent	191	1922	T. H. Harland	
1969	Bruce Kent	199	1921	J. H. Black	196

Manitoba Provincial Champions Handicap

2010	Victoria Jones	91	1968	Larry Wah	94
2009	Pat Lamont	95	1967	H. T. Gardiner	91
2008	Aaron Gyori	98	1966	P. C. Mansoff	98
2007	Leigh Nelson	96	1965	E. E. Kipling	93
2006	Brian Johnson	96	1964	Bruce Kent	95
2005	Jim Turner	93	1963	Bruce Kent	95
2004	John Masniuk	98	1962	Hank Gardiner	91
2003	Alex Gyori	95	1961	H. W. Gibbs	96
2002	Patrick Lamont	97	1960	Howie Gibbs	97
2001	Jamie McCutchin	95	1959	P. C. Mansoff	
2000	Robert Lamont	95	1958	H. T. Gardiner	
1999	Paul Adriaansen	98	1957	Jeff Avery	
1998	Bob Baert	97	1956		
1997	Allan Aplin	92	1955		
1996	Paul Adriaansen	98	1954		
1995	Art Maynard	94	1953		
1994	Rick Ducharme	97	1952		
1993	Jason Sparwood	95	1951	W. Harvey	
1992	Don Smith	95	1950	James Girgulis	99
1991	Bill Avery	94	1949		
1990	Pat Bourns	92	1948	C. C. Plummer	97
1989	Pat Bourns	93	1947	A. E. Brodie	97
1988	Bill Gordon	99	1940	James Girgulis	96
1987	Stan Deneka	93	1939	Jack Evens	92
1986	Keith Morrison	94	1938		
1985	Wes Gullacher	96	1937	Dr. E. G. Nagle	96
1984	Curtis Wennberg	97	1936	Don Hyndman	90
1983	R. W. Wersch	90	1935	H. A. Kemp	86
1982	Alan Panko	93	1934	James Girgulis	92
1981	Michael Ramsey	96	1933	James Girgulis	94
1980	Les Kelly	92	1932	T. H. Harland	98
1979	Les Kelly	95	1931	R. O. Bennel	90
1978	Garth Minish	94	1930	A. J. Von Ferber	96
1977	Kris Fjelsted	94	1929	J. M. Thorson	95
1976	Howie Gibbs	93	1928		
1975	Larry Wah	93	1927	W. G. Wright	92
1974	Norm Baldwin	96	1926	C. G. Haight	92
1973	Norm Baldwin	95	1925	T. M. Harland	93
1972	Stan Orr	92	1924	P. G. Schwager	88
1971	Henry Hlady	93	1923	Joe Avery	96
1970	Don Sutherland	92	1922	P. G. Schwager	90
1969	Archie Street	95	1921	C. C. Plummer	99

Manitoba Provincial Champions

Doubles

2010	Patrick Lamont	98	1972	J. W. Tucker	88
2009	Patrick Lamont	99	1971	Henry Hlady	88
2008	Patrick Lamont	97	1970	S. Morrison	93
2007	Patrick Lamont	99	1969	Bruce Kent	90
2006	Patrick Lamont	99	1968	Ben Hashimoto	94
2005	Patrick Lamont	99	1967	Bruce Kent	81
2004	Curt Amey	97	1966	E. E. Kipling	92
2003	Patrick Lamont	96	1965	Bruce Wennberg	94
2002	Alex Gyori	97	1964	Bruce Kent	89
2001	Jason Sparwood	96	1963	Don Zarow	
2000	Larry Wah	93	1962	Al Smith	84
1999	Paul Adriaansen	97	1961	H. T. Simpson	88
1998	Rob Lamont	97	1960	Harry Simpson	87
1997	Jason Sparwood	96	1959	Harry Simpson	
1996	James Harrower	99	1958	P. C. Mansoff	
1995	Rob Lamont	97	1957	P. C. Mansoff	
1994	J. Harrower	97	1956	E. E. Kipling	
1993	J. Harrower	98	1950	Garth Boesch	90
1992	Larry Wah	96	1948	P. C. Mansoff	
1991	Georg Gerow	91	1947	P. C. Mansoff	
1990	Carl Freisen	92	1940	C. C. Plummer	94
1989	Gene Trail	95	1939	A. E. Brodie	93
1988	Gene Trail	98	1937	C. C. Plummer	46
1987	Stan Orr	91	1936	P. G. Schwager	39
1986	Stan Orr	95	1935	James Girgulis	42
1985	Wes Gullacher	92	1934	A. E. Brodie	43
1984	J. Gribbon	96	1933	James Girgulis	48
1983	J. Gribbon	87	1932	C. C. Plummer	44
1982	Stan Orr	91	1931	P. G. Schwager	38
1981	Howie Gibbs	95	1930	C. C. Plummer	45
1980	Don Johnson	94	1929	James Girgulis	44
1979	Larry Wah	92	1927	C. C. Plummer	45
1978	Don Johnson	95	1926	T. m. Harland	42
1977	Gene Trail	93	1925	P. G. Schwager	46
1976	Gene Trail	93	1924	W. M. Geatros	44
1975	Wes Gullacher	90	1923	C. C. Plummer	46
1974	L. Stoyko	94	1922	P. G. Schwager	44
1973	J. W. Tucker	83	1921	C. C. Plummer	47

Manitoba Provincial Champions Junior

2010	Trevor Lewarton	194	1986	Stan Deneka	190
2009	David Stelck	189	1985	Stan Deneka	172
2008	Trevor Lewarton	189	1984	Jonathon Strickland	158
2007	Gianni Nevieri	193	1983	Jonathon Strickland	161
2006	Justin Tan	189	1982	David Ross	171
2005	Nelson Ridgeway	187	1981	Colin Campbell	95
2004	Aaron Gyori	197	1980	Michael Ramsey	181
2003	Kyle Stephenson	190	1979	Michael Ramsey	185
2002	Kyle Stephenson	187	1978	Mike Enns	183
2001	Patrick Lamont	194	1977	Michael Ramsey	148
2000	Kris Skardal	176	1976	Mike Enns	172
1999	Vince Anderson	192	1975	Bob Sampson	95
1998	Seann Hargraves	182	1974	Bob Hogue	93
1997	Gene Graham	184	1973	George Cherewan, Jr.	97
1996	David Hollosi	194	1972	Carolyn Minish	164
1995	Bob Vassart	195	1971	Jeff Fulcher	95
1994	David Hollosi	194	1969	Jeff Fulcher	93
1993	Bobby Vassart	193	1967	Scott Kent	170
1992	Craig Hawkins	187	1966	J. H. Fulcher	90
1991	Allan Hanks	189	1965	James Ogletree	81
1990	Kevin Wyntinck	163	1964	Seymore Young	95
1989	Kevin Wyntinck	193	1963	Seymore Young	95
1988	Pat Bourns	191	1962	Roy Young	67
1987	Stan Deneka	195			

Manitoba Provincial Champions

Ladies

2010	Katie Jones	191	1987	Emma Moxley	184
2009	Inette Asmundsen	165	1986	Joy Rands	192
2008	Inette Asmundsen	152	1985	Joy Rands	178
2007	Inette Asmundsen	177	1984	Joy Rands	190
2006	Kerry Smith	186	1983	Joy Rands	178
2005	Kerry Smith	157	1982	Joy Rands	174
2004	Kerry Smith	187	1981	Diane Trail	91
2003	Kerry Smith	182	1980	Joy Rands	195
2002	Kerry Smith	195	1979	Joy Warren	192
2001	Kerry Smith	187	1978	Emma Moxley	193
2000	Gerry Aplin	193	1977	Joy Warren	196
1999	Tami Wah	186	1976	Joy Warren	191
1998	Gerri Aplin	180	1975	Carolyn Lumax	185
1997	Gerry Aplin	182	1974	Emma Moxley	87
1996	M. Harrower	189	1973	Carolyn Minish	92
1995	Brandie Colman	181	1972	Marlene Frantz	168
1994	M. Harrower	187	1970	Joy Patman	166
1993	Emma Moxley	192	1950	Mrs. Garth Boeach	184
1992	Diane Trail	183	1937	Mrs. C. C. Plummer	140
1991	Kathy Staples	191	1931	Mrs. C. C. Plummer	161
1990	Kathy Staples	191	1930	Mrs. L. H. Walton	172
1989	Angela Weibe	193	1926	Mrs. C. C. Plummer	137
1988	Kathy Staples	189	1925	Mrs. C. C. Plummer	128

Sub-Junior

2010	Tiger Jones	180	1993	Kevin Aguis	177
2009	Jonathon Tan	145	1992	Bobby Vassart	194
2008	David Steleck	150	1991	Roy Harrower	188
2007	Terell Kerbert	183	1990	Roy Harrower	168
2006	Trvor Lewarton	184	1989	Jason Freeman	169
2005	Trevor Lewarton	160	1988	Mike Deneka	149
2004	Brian Hrominchuk	144	1987	Jason Ferguson	173
2003	Chris Gullacher	172	1986	Keith Morrison	176
2002	Aaron Gyori	186	1985	Curtis Wennberg	161
2001	Blain Cuthbert	179	1984	Curtis Wennberg	183
2000	Patrick Lamont	178	1983	Lars Wennberg	153
1999	Patrick Lamont	188	1982	J. Strickland	164
1998	Patrick Lamont	184	1981		
1997	Guy Verwey	166	1980	Wade Myall	141
1996	Vince Anderson	188	1979	Alan Boulet	182
1995	Vince Anderson	181	1978	Michael Ramsey	181
1994	Zack Price	180			

Manitoba Provincial Champions

Veteran

Senior Veteran

2010	Harry Humby	193	2010	John Harris	170
2009	Glen Morrison	193	2009	John Harris	190
2008	Glen Morrison	184	2008	John Harris	164
2007	Robert Uchtmann	184	2007	John Harris	177
2006	George Gerow	178	2006	John Masniuk	188
2005	no entry		2005	John Harris	167
2004	Art Maynard	190	2004	John Masniuk	193
2003	no entry		2003	John Masniuk	193
2002	John Harris	197	2002	John Masniuk	188
2001	John Harris	169	2001	John Masniuk	181
2000	John Harris	141	2000	Henry Hlady	171
1999	John Harris	172	1999	Bruce Kent	192
1998	George Carr	182	1998	Ray Caron	187
1997	John Masniuk	185	1997	Joe Warren	192
1996	John Masniuk	180	1996	Joe Warren	194
1995	Joe Warren	189	1995	Bruce Kent	184
1994	Joe Warren	192	1994	Bruce Kent	189
1993	Joe Warren	193	1993	Bruce Kent	194
1992	Joe Warren	196	1992	Bruce Kent	196
1991	Joe Warren	199	1991	Henry Hlady	190
1990	George Dimakos	162	1990	Henry Hlady	196
1989	Sid Ackerman	177	1989	Bruce Kent	190
1988	Bruce Kent	173	1988	Henry Hlady	179
1987	Bruce Kent	193	1987	Henry Hlady	192
1986	Norm Shepherd	184	1986	Wes Gullacher	189
1985	Norm Shepherd	170			
1984	Merv Moxley	182			
1983	Norm Shepherd	165			
1979	Tils Forester	177			
1978	W. J. Campbell	178			

Manitoba Provincial Champions All-Around

2010	Patrick Lamont	386	1968	Ben Hashimoto	372
2009	Patrick Lamont	393	1967	Bruce Kent	362
2008	Bob Johnston	369	1966	W. J. Campbell	375
2007	Patrick Lamont	393	1965	E. E. Kipling	372
2006	Patrick Lamont	388	1964	Bruce Kent	376
2005	Robert Lamont	374	1963	Bruce Kent	368
2004	Patrick Lamont	391	1962	Al Smith	362
2003	Curt Amey	387	1961	E. E. Kipling	374
2002	Patrick Lamont	391	1960	H. W. Gibbs	362
2001	Bob Johnston	389	1959		
2000	Robert Lamont	378	1958		
1999	P. Adriaansen	391	1957		
1998	Robert Lamont	389	1956		
1997	Pat Bourns	382	1955		
1996	Robert Lamont	385	1954		
1995	Larry Wah	381	1953		
1994	Rod Stuart	381	1952		
1993	J. Harrower	381	1951		
1992	Larry Wah	385	1950	Garth Boesch	376
1991	Stan Orr	375	1949		
1990	Stan Orr	373	1948	James Girgulis	347
1989	Stan Orr	385	1947	A. E. Brodie	385
1988	Stan Orr	381	1940	C. C. Plummer	383
1987	Stan Deneka	379	1939	C. C. Plummer	320
1986	Alex Gyori	374	1938		
1985	Alex Gyori	364	1937	James Girgulis	332
1984	J. Gribbon	373	1936	A. E. Brodie	317
1983	A. McDonell	359	1935	James Girgulis	299
1982	Alan Panko	359	1934	A. E. Brodie	371
1981	Joe Gribbon	378	1933	James Girgulis	391
1980	Joe Gribbon	367	1932		
1979	Howie Gibbs	382	1931		
1978	Al McDonnell	370	1930	A. E. Brodie	327
1977	Gene Trail	377	1929	P. G. Schwager	332
1976	Norm Baldwin	370	1928		
1975	George McCabe	377	1927	P. G. Schwager	332
1974	Norm Baldwin	373	1926	T. M. Harland	312
1973	J. W. Tucker	369	1925	T. M. Harland	328
1972	J. W. Tucker	368	1924		
1971	W. J. Campbell	369	1923	C. C. Plummer	321
1970	Bruce Kent	367	1922	C. C. Plummer	314
1969	Holly Simpson	273	1921	C. C. Plummer	337

List of Advertisers

*We thank the following advertisers for their support
and urge our patrons to support these businesses in return.*

A Pet Lover's Warehouse Ltd.	Mid-Plains Implements Ltd.
AgWest Equipment Ltd.	Moonlight Autobody Ltd.
Barry Gordon / Royal LePage	Papa George's
BayWash	Perazzi Canada
Bill's Sticky Fingers	Pinegrove Gunworks
Brian Konrad - Shooting Coach	Promatic
Brian Konrad - Investors Group	RDP Gunsmithing
CanadInns - Brandon	Redwood Motor Inn
CanadInns - Portage la Prairie	Spud Plains Farms Ltd.
Casablanca Motor Inn / The Little Chalet	Subway
Colonial Inn	T.A. Ferguson & Associates Inc.
Delmar Commodities	The Outpost Grill
Gislason Targownik Peters Certified General Accountants	The Wood Joynt Ltd.
Home Hardware Building Centre	Thunderbird Bowl
Jo Brook Firearms	TJ Auto Repair
Lock & Load Shooting Sports	Westoba Credit Union Ltd.
MacDonald's Sporting Goods Ltd.	Westward Ford
McLaren's Metal Shop	Wholesale Sports Outdoor Outfitters



Making the World's Finest Clay Pigeon Traps for Over 20 Years

**Over 50 models and 50,000 traps now installed worldwide
Covering Sporting Clays, FITASC, 5 Stand, Wing Shooting, Skeet,
ATA Trap, Olympic Trap and Olympic Skeet.**



International Double ATA
Doubles or Singles with outstanding quality
Targets. Works every time in the cold, wet or
heat. Never need to heat your trap house
again.



Harrier
Ideal for groups such as friends and family or a
small members club because it offers three
times the capacity of our single stack machines.



Ranger Chondel/Rabbit
Throws conventional clays either just above
the Ground, or as loopers or near vertical teal,
as well as rabbit targets along the ground.



Huntsman Wing Shooter
The only choice for true simulated bird targets
with speed and random movement to test
even the best wing shooter.



Elite
Want to improve your shooting skills?
This is the most competitively priced automatic
trap available. For single use and small clubs,
ideal for training and leisure.

Distributed in Canada by T.A. Ferguson & Associates Inc.

Ph. 1-800-361-1023

Visit Promatic at www.promatic.biz to view the complete line

Promatic Inc. introduces the new

Double ATA Machine

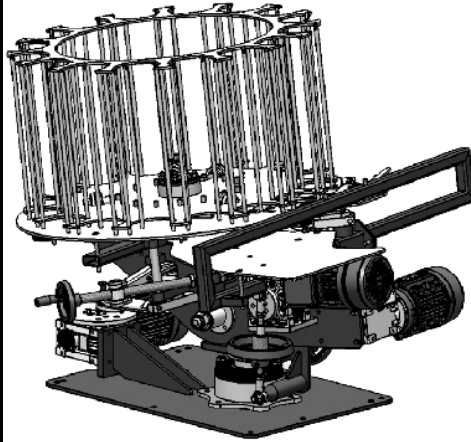

Promatic has introduced a completely redesigned ATA doubles machine for the American ATA market.

The new Double ATA has been redesigned from the base up and adds many new features including improved performance, durability and the ability to adjust height, spring tension and tilt without the use of a wrench, making the change from singles to doubles quick and easy.

Standard features will include:

- Sixteen column 550 target carousel means the overall trap height is reduced.
- Upgraded bearings and linkages for increased durability.
- Steel mainframe with hard blue polyester finish.
- Solenoid Release for instant and accurate target release.
- Aluminum throwing arm with Polyurethane strip.
- Height adjustment without the need for using a wrench.
- Spring adjustment without the need for using a wrench.
- Tilt adjustment without the need for using a wrench.
- Quick and easy switch from singles to doubles.
- 12v or 110v via transformer.
- Durable and simple 12v electrical control box with random interrupter.
- Double Wobble version also available.
- 3 year warranty.



Distributed in Canada by:

T.A. Ferguson & Associates Inc.

Box 10189, Airdrie, Alberta T4A 0H5 • Email aa27aa@gmail.com
Phone 403-935-5595 • Fax 403-935-5565 • Toll Free 1-800-361-1023

T. A. FERGUSON & ASSOCIATES INC.

**Box 10189, Airdrie, Alberta T4A 0H5
Phone (403) 935-5595 Fax (403) 935-5565**

1-800-361-1023

Manufacturer's Representative for:

BROWNING

THE BEST IN HUNTING AND FISHING PRODUCTS

MUSTANG SURVIVAL

RECREATIONAL & INDUSTRIAL FLOTATION PRODUCTS

WINCHESTER

RIFLES AND SHOTGUNS

MUSTANG SURVIVAL

RECREATIONAL & INDUSTRIAL FLOTATION PRODUCTS

CALDWELL INDUSTRIES

CANADIAN MADE TRAP AND SKEET TARGETS

REAGENT CHEMICAL

WHITE FLYER CLAY TARGETS

FOR TRAP, SKEET & SPORTING CLAYS

AUTO SPORTER INDUSTRIES INC.

CLAY TARGET TRAPS

GOOD LUCK SHOOTERS!

from

Tom Ferguson

Jo Brook Firearms

909-24th Street
Brandon, MB R7B 1Y5
204-727-3552

Sporting firearms by:

- Browning
- Tikka
- Savage
- Remington
- Cooper
- Thompson Center
- Beretta
- Ruger
- Weatherby
- Benelli
- Marlin

Target shotguns by:

- Beretta
- Browning

Rifle scopes by:

- Bushnell
- Leupold
- Night Force
- Tasco
- Redfield

Complete line of hunting accessories,
archery equipment,
hunting clothing and boots.

Target ammunition by Federal and Winchester.

*Good Luck to all shooters
from Travis and staff.*